

# Clarke®

## METALWORKER



## BENCH GRINDER

### MODEL NO: CHDBG500

PART NO: 6500535

## OPERATION & MAINTENANCE INSTRUCTIONS



ORIGINAL INSTRUCTIONS

GC0121 - rev 2

---

## INTRODUCTION

---

Thank you for purchasing this CLARKE Bench Grinder.

Before attempting to use this product, please read this manual thoroughly and follow the instructions carefully. In doing so you will ensure the safety of yourself and that of others around you, and you can look forward to your purchase giving you long and satisfactory service.

---

## GUARANTEE

---

This product is guaranteed against faulty manufacture for a period of 12 months from the date of purchase. Please keep your receipt which will be required as proof of purchase.

This guarantee is invalid if the product is found to have been abused or tampered with in any way, or not used for the purpose for which it was intended.

Faulty goods should be returned to their place of purchase, no product can be returned to us without prior permission.

This guarantee does not effect your statutory rights.

---

## ENVIRONMENTAL RECYCLING POLICY

---



Through purchase of this product, the customer is taking on the obligation to deal with the WEEE in accordance with the WEEE regulations in relation to the treatment, recycling & recovery and environmentally sound disposal of the WEEE.

In effect, this means that this product must not be disposed of with general household waste. It must be disposed of according to the laws governing Waste Electrical and Electronic Equipment (WEEE) at a recognised disposal facility.

If disposing of this product or any damaged components, do not dispose of with general waste. This product contains valuable raw materials. Metal products should be taken to your local civic amenity site for recycling of metal products.

---

## SPECIFICATIONS

---

Model Number	CHDBG500
Part Number	6500535
Dimensions (D x W x H)	466 x 194 x 254 mm
Weight	16.5 kg
Rated Voltage	230 V~ 50 Hz
Rated Input Wattage	500 W
No Load Speed	2850 RPM (+/- 5%)
Abrasive wheels supplied	Coarse (36 Grit), Fine (80 Grit)
Wheel dimensions	Diameter (150 mm) Thickness (25 mm) Bore (32 mm)
Duty Cycle classification	S2/30 minutes
Sound pressure	78 dB(A)
Sound power (measured)	97 dB LpA
Sound power (Guaranteed)	98 dB LwA
Uncertainty factor K	0.42 dB

---

## POWER TOOL SAFETY WARNINGS

---

### WORK AREA

1. **Keep the work area clean and well lit.** Cluttered and dark areas invite accidents.
2. **Do not operate power tools in explosive atmospheres, such as in the presence of flammable liquids, gases or dust.** Power tools create sparks which may ignite the dust or fumes.
3. **Keep children and bystanders away while operating a power tool.** Distractions can cause you to lose control.

### ELECTRICAL SAFETY

1. **Power tool plugs must match the outlet. Never modify the plug in any way. Do not use adapter plugs with earthed (grounded) power tools.** Unmodified plugs and matching outlets will reduce the risk of electric shock.

2. **Do not expose power tools to rain or wet conditions.** Water entering a power tool will increase the risk of electric shock.
3. **Do not abuse the power cable. Never use it for carrying, pulling or unplugging the power tool. Keep the power cable away from heat, oil, sharp edges or moving parts.** Damaged or entangled cables increase the risk of electric shock.
4. **When operating a power tool outdoors, use an extension cable suitable for outdoor use.** Use of a cable suitable for outdoor use reduces the risk of electric shock.
5. **If operating the power tool in a damp location is unavoidable, use a residual current device (RCD) protected supply.**

## PERSONAL SAFETY

1. **Stay alert, watch what you are doing and use common sense when operating a power tool.** Do not use a power tool while you are tired or under the influence of drugs, alcohol or medication. A moment of inattention while operating power tools may result in personal injury.
2. **Use safety equipment. Always wear eye protection.** Safety equipment such as dust mask, non-skid safety shoes, hard hat, or hearing protection used for appropriate conditions will reduce personal injuries.
3. **Avoid accidental starting.** Ensure the switch is in the off position before plugging in. Carrying power tools with your finger on the switch or plugging in power tools that have the switch on invites accidents.
4. **Remove any wrench before turning the power tool on.** A wrench left attached to a rotating part may result in personal injury.
5. **Do not overreach.** Keep proper footing and balance at all times. This enables better control of the power tool in unexpected situations.
6. **Dress properly.** Do not wear loose clothing or jewellery. Keep your hair, clothing and gloves away from moving parts. Loose clothes, jewellery or long hair can be caught in moving parts.

## POWER TOOL USE AND CARE

1. **Do not force the power tool.** Use the correct accessories for your application. The correct power tool will do the job better and safer at the rate which it was designed.
2. **Do not use the power tool if the switch does not turn it on and off.** Any power tool that cannot be controlled with the switch is dangerous and must be repaired.
3. **Disconnect the plug from the power source before changing accessories, or storing power tools.** Such preventive safety measures reduce the risk of starting the power tool accidentally.

4. **Store idle tools out of the reach of children and do not allow persons unfamiliar with the power tool or these instructions to operate it.** Power tools are dangerous in the hands of untrained users.
5. **Maintain power tools.** Check for misalignment or binding of moving parts, breakage of parts and any other condition that may affect the power tool's operation. If damaged, have the power tool repaired before use. Many accidents are caused by poorly maintained power tools.
6. **Use the power tool and accessories in accordance with these instructions and in the manner intended, taking into account the working conditions and the work to be performed.** Use of the power tool for operations different from intended could result in a hazardous situation.
7. The performance of this tool may vary, depending upon variations in line voltage. Extension cable usage may also affect performance.

## SERVICE

1. **Have your power tool serviced by qualified service personnel using only identical replacement parts.** This will ensure that the safety of the power tool is maintained.

---

## BENCH GRINDER SAFETY WARNINGS

---

1. Hold the tool or blade being sharpened firmly to prevent loss of control.
2. NEVER install a abrasive flap wheel or sanding disc on this grinder.
3. ALWAYS replace a cracked grinding wheel immediately.
4. NEVER use damaged or incorrect grindstones. The stone and retaining bolt were specially designed for your grinder, for optimum performance and safety of operation. Inspect the condition of the grinding stone before use and do not use if any damage is noticed.
5. Do not use aluminium oxide wheels when grinding non-ferrous metals such as aluminium or brass. Use silicon carbide wheels (not included) for grinding non-ferrous metals.
6. ALWAYS use the rests to steady the workpiece. If the rests are not used, the torque of the spinning grinding/polishing wheel may pull the workpiece from your hands.
7. NEVER leave the grinder unattended when it is connected to an electrical power supply. Switch off the grinder and unplug it before leaving.
8. ALWAYS check for damaged parts. Before further use of the tool, a guard or other part that is damaged should be carefully checked to determine if it would operate properly and perform its intended function. Check for misalignment or binding of moving parts, breakage of parts and any other condition that may affect the tool's operation. A part that is damaged

should be properly repaired or replaced at an authorised service centre. Following this rule will reduce the risk of electric shock, fire or serious injury.

9. Gloves, manufactured to the current European safety standards should be worn when operating grinding equipment.
10. Eye protection manufactured to the current European safety standards should be worn when operating grinding equipment.

**NOTE:** *Bench grinders used in industrial environments may be subject to the requirements of The Provision and Use of Work Equipment regulations 1992 (particularly regarding the training requirement of The Abrasive Wheels Regulations 1970) or other legislation. If in doubt seek advice.*

**Please keep these instructions in a safe place for future reference.**

---

## SAFETY SYMBOLS

---



Read instruction manual before use



This machine is not suitable for hand held use



Not permitted for wet grinding



Wear eye protection



Wear ear defenders



Wear protective gloves

## ELECTRICAL CONNECTIONS



**WARNING: READ THESE ELECTRICAL SAFETY INSTRUCTIONS THOROUGHLY BEFORE CONNECTING THE PRODUCT TO THE MAINS SUPPLY.**

Connect the mains lead to a standard, 230 Volt (50Hz) electrical supply through an approved BS 1363 plug or a suitably fused isolator switch.

If the plug has to be changed because it is not suitable for your socket, or because of damage, it must be removed and a replacement fitted, following the wiring instructions shown below. The old plug must be discarded safely, as insertion into a power socket could cause an electrical hazard.



**WARNING: THE WIRES IN THE POWER CABLE OF THIS PRODUCT ARE COLOURED IN ACCORDANCE WITH THE FOLLOWING CODE:  
BLUE = NEUTRAL    BROWN = LIVE    YELLOW AND GREEN = EARTH**

If the colours of the wires in the power cable do not agree with the markings on the plug.

- Connect the BLUE wire to the terminal marked N.
- Connect the BROWN wire to the terminal marked L.
- Connect the YELLOW AND GREEN wire to the terminal marked E or  $\perp$ .

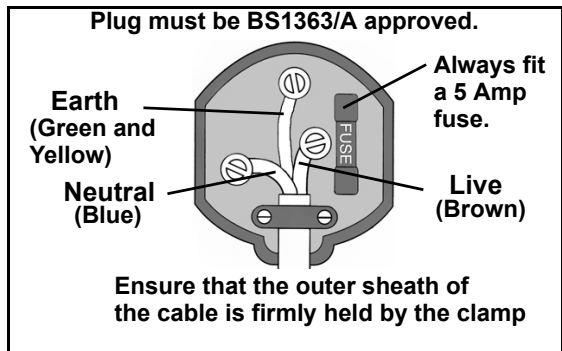

**AN APPROVED RESIDUAL CURRENT DEVICE (RCD) WHICH HAS A TRIPPING CURRENT OF LESS THAN 30 mA MUST BE USED.**

If you are not sure, consult a qualified electrician. DO NOT try to do any repairs.

## CARTON CONTENTS

The following items should be supplied in the carton. If any parts are missing or damaged, please contact the CLARKE dealer where you purchased the bench grinder.

1 x Bench grinder assembly (c/w 2 grinding wheels attached)
2 x Eye shields and holders (1 with magnifying lens)
2 x Eye shield arms
2 x Eye shield brackets with bolts and washers
2 x Tool rest retaining nuts
2 x Spark deflectors with screws and washers
2 x Tool rests (left & right hand)

## PART IDENTIFICATION

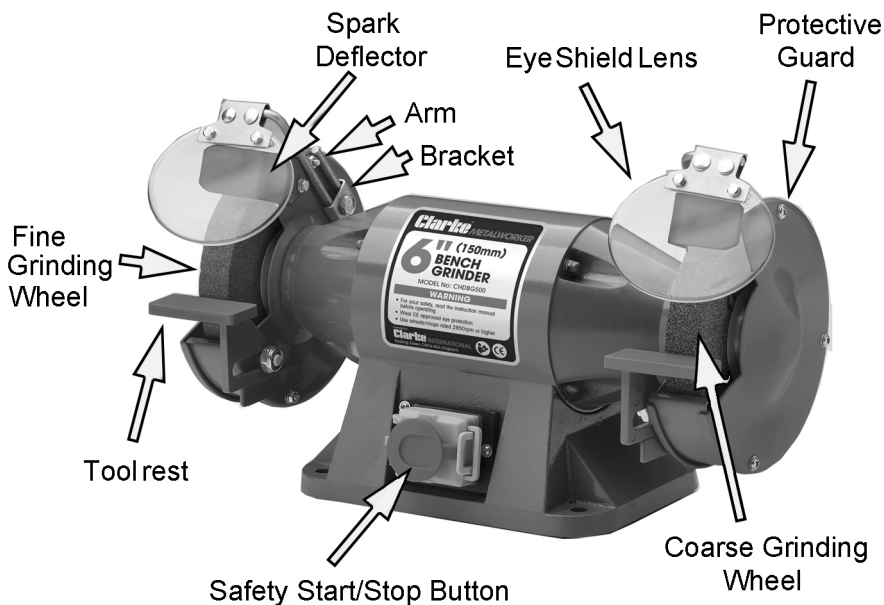



# BEFORE USE

## MOUNTING THE GRINDER ONTO A WORKBENCH

**NOTE:** We highly recommend that you bolt this bench grinder securely to a workbench to gain maximum stability.

1. Using the base of the bench grinder as a template, mark the bench through the holes in the casting.
2. Bolt the bench grinder on the bench with bolts, washers and nuts (not supplied).
3. To reduce vibration, mount the bench grinder on a vibration absorbing mat.



## INSTALLING THE TOOL RESTS

1. Fix the tool rests to the bench grinder with the retaining nut as shown.
  - The tool rests are adjustable and should be positioned 1.5 mm from the grinding wheels.
  - Ensure that the tool rest is firmly fixed and horizontal.

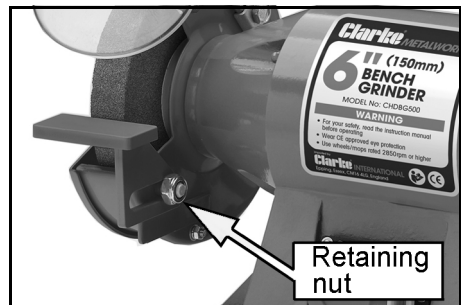

## INSTALLING THE SPARK DEFLECTORS

Fit both the spark deflectors to the wheel guards using the bolts provided.

- Adjust the spark deflector to compensate for wear of the wheel. Keep the distance between the spark deflector and wheel as small as possible and never more than 2 mm.

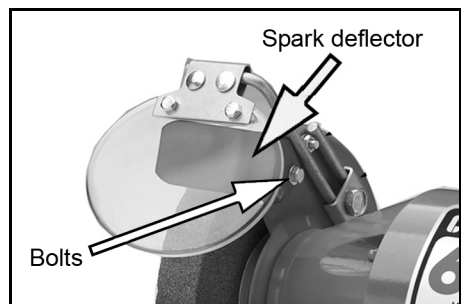

## INSTALLING THE EYE SHIELDS

1. Attach the left eye shield arm to the bench grinder using the bracket, washer and bolt supplied.

**NOTE:** Adjust the eye shields to an appropriate distance from the tool rests avoiding interference during operation.

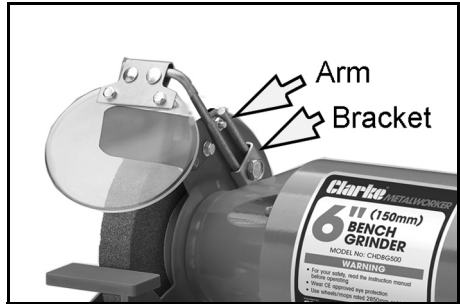

---

## OPERATION

---



**CAUTION:** KEEP ALL BYSTANDERS A SAFE DISTANCE AND NOT IN DIRECT LINE, FRONT OR BACK OF THE GRINDER.

**CAUTION:** ALWAYS WEAR SAFETY GLASSES.

---

**NOTE:** Check that there is approx a 1.5 mm clearance between the tool rest and the surface of the grinding wheel. Adjust as necessary.

**NOTE:** Check the gap between the spark deflectors and the surface of the grinding wheel. These should also be a maximum of 2 mm. Adjust as necessary.

**NOTE:** Check that the eyeshields have been secured in the correct position and that the grinding wheel lock nuts are tight.

1. Stand to the side of the bench grinder and switch it on using the on/off switch.
  - Let the wheels reach full speed before use.
  - The wheel rotates in the same direction as the arrow stamped in the side of the wheel guard.
2. Hold the work piece firmly against the tool rest. Hold very small pieces with pliers or other suitable clamps.
3. Press the workpiece smoothly and evenly against the grinding wheel.
4. Always keep the workpiece moving across the face of the wheel. Grinding against the same part of the wheel will cause uneven wear of the wheel face.
  - Grind only on the face of the grinding wheel and never the side of it.

**NOTE:** Prolonged grinding will cause tools/workpieces to become hot. Take care when handling hot items.

5. Switch the bench grinder off using the on/off switch when you have finished.

## DRESSING THE GRINDING WHEEL

The grinding wheel may need dressing occasionally. Only dress the wheel with a proper dressing tool, whilst wearing safety goggles or glasses. If in doubt seek professional advice. Dressing tools are available from your CLARKE Dealer.

Grinding wheel dresser model no ET125;- part no 1700225

---

## SHARPENING TIPS

---

### SCISSORS

If possible, take the scissors apart to make the sharpening operation easier and safer. Remove material only from the outside surface and work from the heavy end of the blade toward the tip.

### KNIVES

Remove metal from both faces of most knives, working from the large end of the blade toward the tip.

---

## REPLACING THE GRINDING WHEELS

---

**WARNING: DO NOT USE DAMAGED GRINDING WHEELS.**



**WARNING: SWITCH THE GRINDER OFF AND DISCONNECT THE POWER SUPPLY BEFORE CHANGING THE GRINDING WHEELS**

The grinding wheel must be replaced whenever the distance between the external diameter of the wheel and the edge of the grinding wheel cover is greater than 6 mm.

1. Remove the screws shown and lift off the cover.
2. Hold the other wheel by hand and remove the nut and outer disc from the damaged wheel.

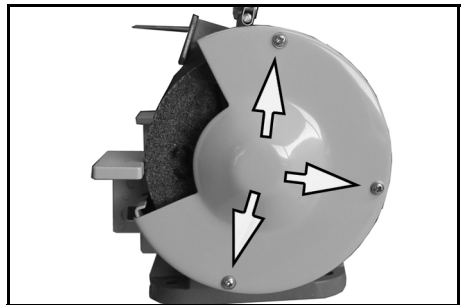

**NOTE:** The left hand grinding wheel locking nut has a left handed thread.

3. Slide off the grinding wheel and replace with a new one. Be sure to fit the paper discs between the new grinding wheel and the inner and outer retaining discs.
  - Only use grinding wheels recommended by the manufacturer which have a marked speed rating equal to or greater than the speed marked on the rating plate of the bench grinder.
  - The disc should have maximum dimensions of 150 mm diameter, 25 mm thick with a bore size of 32 mm.
  - Inspect the wheel for cracks, chips or any other visible damage. Damaged grinding wheels must be discarded.
4. Replace the outer disc with the boss entering the grinding wheel.
5. Replace the nut securely.
  - Do not overtighten as this may damage the grinding wheel.
6. Re-assemble the guards fully prior to trial running the grinding wheel.
  - Each time after mounting, the wheel should be test run for a reasonable time (approximately 1 minute) to demonstrate true running.

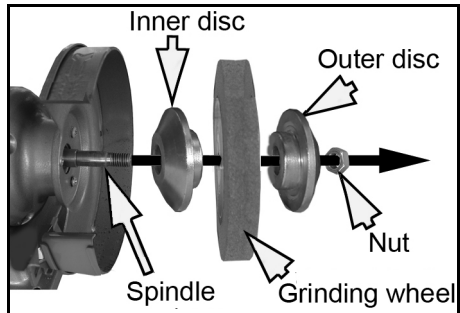

## SUITABLE GRINDING WHEELS

The following grinding wheels are available for this bench grinder from your CLARKE dealer.

- Coarse (36 Grit), CLARKE part no 6500539
- Medium (60 grit), CLARKE part no 6500538
- Fine (80 Grit), CLARKE part no 6500537

# DECLARATION OF CONFORMITY



**Clarke**<sup>®</sup>  
**INTERNATIONAL**

Hemnall Street, Epping, Essex CM16 4LG

## DECLARATION OF CONFORMITY

This is an important document and should be retained.

We hereby declare that this product(s) complies with the following directive(s):

2014/30/EU      *Electromagnetic Compatibility Directive.*  
2006/42/EC      *Machinery Directive.*  
2011/65/EU      *Restriction of Hazardous substances*

The following standards have been applied to the product(s):

*EN 61029-1:2009+A11:2010, EN 61029-2-4:2011, EN 61000-6-4:2007+A1:2011,  
EN 61000-6-2:2005+AC:2005, EN ISO 12100:2010, EN 60204-1:2006+A1:2009+AC:2010.*

The technical documentation required to demonstrate that the product(s) meet(s) the requirement(s) of the aforementioned directive(s) has been compiled and is available for inspection by the relevant enforcement authorities.

The CE mark was first applied in: 2019

**Product Description:**            500W 150mm Bench Grinder  
**Model number(s):**            CHDBG500  
**Serial / batch Number:**        N/A  
**Date of Issue:**                25/06/2019

Signed:

**J.A. Clarke**  
**Director**

# PARTS DIAGRAM

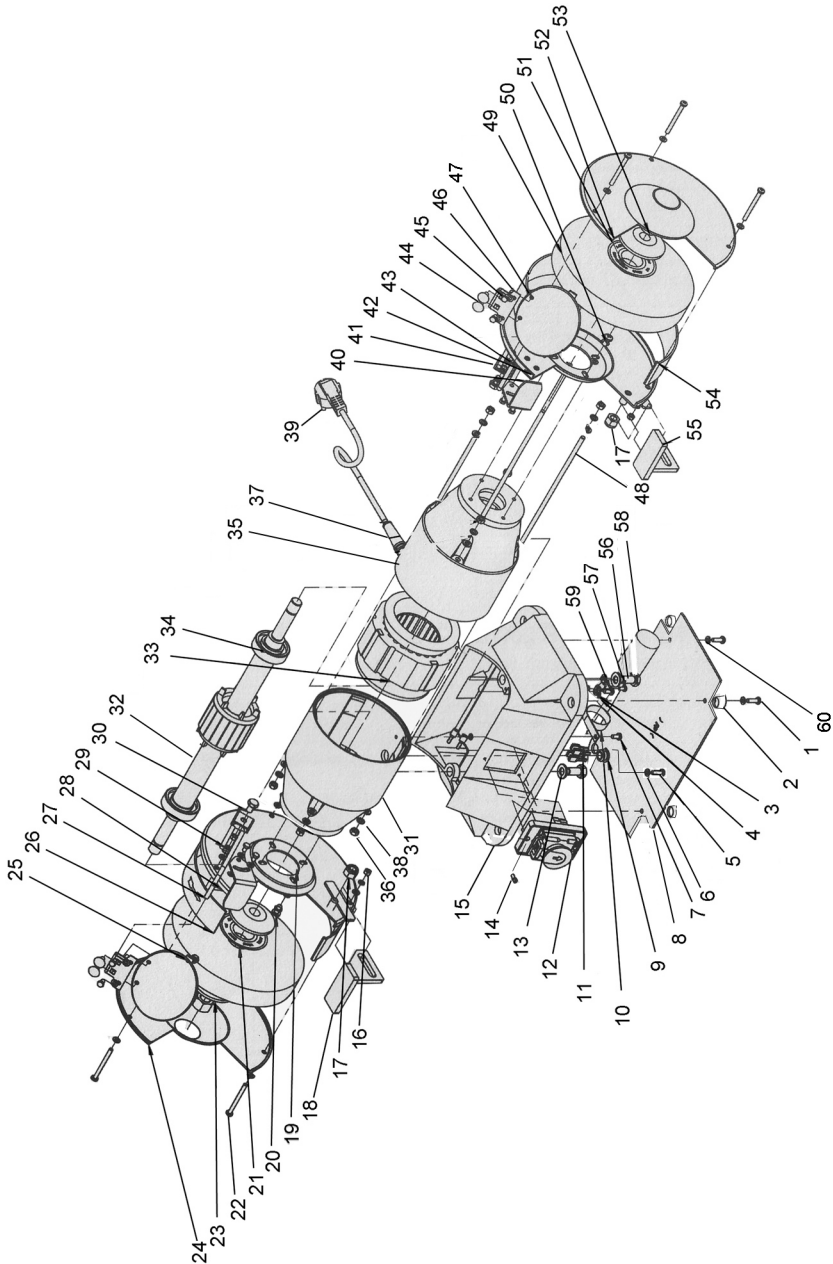

## PART LIST

1	Screw M5 x 16
2	Bottom Foot
3	Cable Clamp
4	Earthing Point
5	Bolt 4mm
6	Washer 4mm
7	Screw M5 x 10
8	Bottom Plate
9	Cable Sheathing
10	Capacitor Clamp
11	Rubber Cover
12	Power Switch
13	Washer
14	Screw M4 x10
15	Machine Frame
16	Nut M5
17	Locknut M10
18	Toolrest (LH)
19	Spacer
20	Screw M6 x12
21	Paper Disc
22	Screw M5 x 55
23	Outer Securing Disc
24	Protective Cover (LH)
25	Eye Shield Lens
26	Left Wheel Cover
27	Eye Shield Arm (LH)
28	Grinding Wheel Inner Cover (LH)
29	Snap Ring
30	Bolt 8 x 12

31	Housing (RH)
32	Motor Shaft
33	Stator
34	Shaft Bearing 6205
35	Housing (RH)
36	Domed Nut M6
37	Power Cable Gland
38	Washer 6mm
39	Power Cable with Plug
40	Spark Deflector
41	Bracket
42	Grinding Wheel Inner Cover (RH)
43	Spark Deflector Mounting (RH)
44	Coachbolt M6 x 12
45	Bolt M5 x 8
46	Eye Shield Bracket
47	Eye Shield Lens
48	Bolt
49	Grinding Wheel
50	Screw
51	Paper Disc
52	Protective Cover (RH)
53	Outer Securing Disc
54	Right Wheel Cover
55	Toolrest (RH)
56	Bolt M10 x 20
57	Screw M5 x 8
58	Capacitor 25uf
59	Snap Ring
60	Washer 5mm

# A SELECTION FROM THE VAST RANGE OF

# Clarke®

## QUALITY PRODUCTS



### **AIR COMPRESSORS**

From DIY to industrial, Plus air tools, spray guns and accessories.

### **GENERATORS**

Prime duty or emergency standby for business, home and leisure.

### **POWER WASHERS**

Hot and cold, electric and engine driven - we have what you need

### **WELDERS**

Mig, Arc, Tig and Spot. From DIY to auto/industrial.

### **METALWORKING**

Drills, grinders and saws for DIY and professional use.

### **WOODWORKING**

Saws, sanders, lathes, mortisers and dust extraction.

### **HYDRAULICS**

Cranes, body repair kits, transmission jacks for all types of workshop use.

### **WATER PUMPS**

Submersible, electric and engine driven for DIY, agriculture and industry.

### **POWER TOOLS**

Angle grinders, cordless drill sets, saws and sanders.

### **STARTERS/CHARGERS**

All sizes for car and commercial use.

## **PARTS & SERVICE:**

## **0208 988 7400**

### **Parts Enquiries**

[Parts@clarkeinternational.com](mailto:Parts@clarkeinternational.com)

### **Servicing & Technical Enquiries**

[Service@clarkeinternational.com](mailto:Service@clarkeinternational.com)

SALES: UK 01992 565333 or Export 00 44 (0)1992 565335

**Clarke** INTERNATIONAL Hemnall Street, Epping, Essex CM16 4LG  
[www.clarkeinternational.com](http://www.clarkeinternational.com)